



# CONFORTO

## THE NEW GENERATION OF OIL-FIRED WARM AIR FURNACES



4-WAY MULTIPOISE (KHM)

CHE 95%+ LOWBOY REAR BREECH (KLC)

LOWBOY FRONT BREECH (KLF)

LOWBOY REAR BREECH (KLR)

### + PERFORMANCE



ENERGY STAR® CERTIFIED  
AT ALL FIRING RATES\*

### + COMFORTABLE

A MORE EVEN HEAT AND A QUICKER,  
MORE PRECISE RESPONSE TO A CALL  
FOR HEAT FROM THE THERMOSTAT

### + ECONOMICAL OPERATION

ANNUAL EFFICIENCY RANGING  
FROM 86% TO 96.7%  
HIGH-EFFICIENCY ECM BLOWER MOTORS

### + EASE OF MAINTENANCE

DUE TO ITS NON-REFRACTORY COMBUSTION  
CHAMBER AND TUBULAR SECONDARY  
HEAT EXCHANGERS

### + VERSATILE

CERTIFIED FOR CONVERSION TO GAS BURNER (88+  
SERIES)

AFUE UP TO **96.7%** (OIL)

# UNMATCHED PERFORMANCE, SAVINGS AT YOUR REACH

With Riello burner only.



CONDENSING HIGH EFFICIENCY



KLC

THE CONFORTO CHE (CONDENSING HIGH EFFICIENCY) FURNACE IS THE FIRST OIL-FIRED FURNACE BUILT FOR HOMEOWNERS WHO EXPECT UNSURPASSED PERFORMANCE AND ENERGY EFFICIENCY. ITS INNOVATIVE OPERATION WILL HAVE YOU PROFIT FROM A 96%+ HEATING EFFICIENCY ALONG WITH SUPERIOR PERFORMANCE AND COMFORT. THIS PERFORMANCE COULD HELP YOU SAVE UP TO 40% ON YOUR HEATING OIL CONSUMPTION AND COULD REDUCE YOUR GREENHOUSE GAS (GHG) EMISSIONS BY UP TO 3,000 LB./YR! IN ADDITION TO ITS ATTRACTIVE LOOK, THE CONFORTO CHE HOLDS THE ENERGY STAR® CERTIFICATION AT ALL FIRING RATES. ITS CONCEPTION COMBINING PERFORMANCE AND DURABILITY WILL BRING YOU THE BEST COMFORT POSSIBLE AND THE EASE OF MAINTENANCE THAT YOU ARE LOOKING FOR.

## FEATURES

### 1 ROBUST AND DURABLE COMBUSTION CHAMBER

- 100% premium stainless steel construction
- European design
- Heats up more quickly
- Helps in maintaining a more even temperature in the home
- Brings additional heating oil savings compared to conventional appliances
- More durable
- Easier to service

### 2 SECONDARY TUBULAR HEAT EXCHANGERS

- 100% welded one-piece heat exchanger, no bolts and fasteners
- 100% premium stainless steel
- Provided with stainless steel baffles to maximize heat transfer from the heat exchanger
- The tubular design of the secondary heat exchanger provides a quiet and maximum thermal exchange
- Due to its low restriction to the circulating air, this appliance is compatible with today's high-efficiency heat pumps or air conditioning systems

### 3 HIGH-EFFICIENCY BLOWER

- Blower supplied with high-efficiency ECM motor
- Brings additional operating utility savings compared to conventional blower motors
- Innovative blower removal system for easy servicing and maintenance

### 4 SAFE AND EASY-TO-USE ELECTRONIC CONTROL

- Oversees the safe burner operation and speeds of the fan motor
- Provides on-board connections for optional electronic air cleaner and humidifier
- On-board connections for A/C systems
- Continuous low-speed fan switch
- Compatible with heat pumps operating controls

### 5 HIGH-EFFICIENCY OIL & GAS BURNERS

- Offered with high static pressure oil burners that offer a better control of the combustion excess air allowing for a cleaner and more efficient combustion
- Electronic safety controls
- High-power electronic ignition

### 6 VENTING OPTIONS

- Balanced flue burner with through-the-wall or through-the-roof coaxial or two-pipe venting systems using approved plastic piping
- Single-pipe approved plastic venting using an existing chimney chase along with a standard burner
- Comes standard with an auto-reset pressure switch protection device in case of flue or air intake blockage

### 7 NO DAMAGE TO THE ENVIRONMENT

- Factory-installed condensate neutralizing cartridge
  - Neutralizes the acid content on the condensate liquid to allow evacuation of the condensate liquid to the house's plumbing
  - Supplied with every furnace
  - Easy to replace

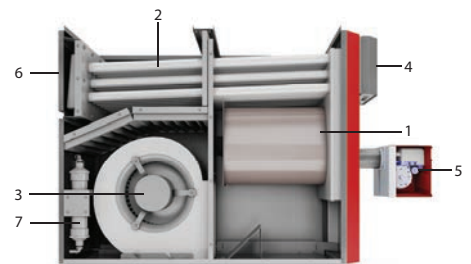

KLC

# OPTIMAL EFFICIENCY, UNCOMPROMISED COMFORT



THE CONFORTO FURNACE IS THE FIRST NORTH AMERICAN OIL-FIRED APPLIANCE THAT HOLDS THE ENERGY STAR® CERTIFICATION AT ALL FIRING RATES AND THAT CAN ALSO BE CONVERTED TO NATURAL OR PROPANE GAS. THE CONFORTO WAS ENGINEERED WITH PERFORMANCE IN MIND, WHICH WILL BRING YOU QUALITY AND COMFORT WITH NO COMPROMISE. ITS ATTRACTIVE LOOK COMBINES THE DURABILITY AND EASE OF MAINTENANCE THAT YOU ARE LOOKING FOR.



UNITS OFFERED WITH BURNERS

**Beckett** Oil burner

**RIELLO** Oil and gas burners

Picture shown with a RIELLO burner.

## FEATURES

### 1 ROBUST AND DURABLE COMBUSTION CHAMBER

- 100% premium stainless steel construction
- European design
- Heats up more quickly
- Helps in maintaining a more even temperature in the home
- Brings additional heating savings compared to conventional appliances
- More durable
- Easier to service

### 2 SECONDARY TUBULAR HEAT EXCHANGERS

- 100% welded one-piece heat exchanger, no bolts and fasteners
- Premium steel
- Provided with stainless steel baffles to maximize heat transfer from the heat exchanger
- The tubular design of the secondary heat exchanger provides a quiet, and maximum thermal exchange
- Due to their low restriction to the circulating air, these appliances are compatible with today's high-efficiency heat pumps or air conditioning systems

### 3 BLOWER OPTIONS

- Comes standard with standard efficiency PSC blower motors or with high-efficiency ECM blower motors
  - The ECM type motor provides additional operating utility savings compared to conventional motors
- Easy-to-remove system for service and maintenance

### 4 SAFE AND EASY-TO-USE ELECTRONIC CONTROL

- Oversees the safe burner operation and speeds of the fan motor
- Provides on-board connections for optional electronic air cleaner and humidifier
- On-board connections for A/C systems
- Continuous low-speed fan switch
- Compatible with heat pumps operating controls

### 5 HIGH-EFFICIENCY BURNERS

- Offered with high static pressure burners that offer a better control of the combustion excess air allowing for a cleaner and more efficient combustion
- Electronic safety controls
- High-power electronic ignition

### 6 VENTING OPTIONS

- Rear breach (KLR) or front breach (KLF & KHM)
- Can be vented using a standard chimney and standard burner or using the Granby DVS (Direct Vent System) – through-the-wall venting with a balanced flue burner. This is applicable only for the oil-fired appliance.

### HIBOY – MULTIPOISE (KHM)

- One unit – 4 installation options
  - Upflow
  - Downflow
  - Horizontal right
  - Horizontal left
- Can be installed anywhere thanks to its small footprint
- Triple-pass heat exchanger offering the highest heating efficiency for a standard hiboy furnace – the best performing unit of its kind on the market

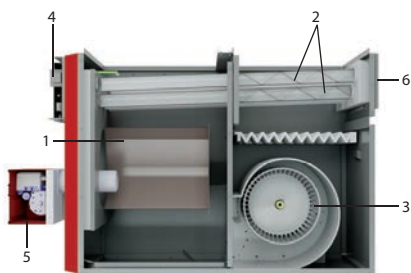

KLR

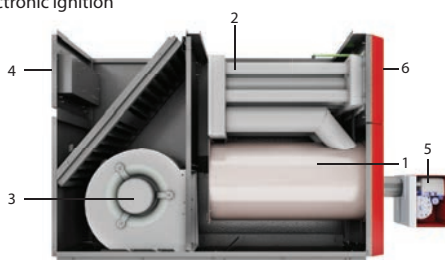

KLF

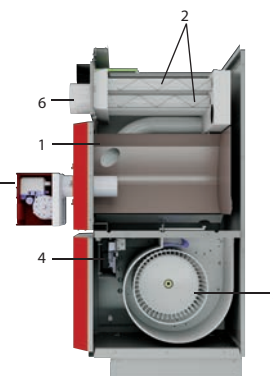

KHM



**Specifications**

Furnace model	KLC-100	KLR-100	KLR-200	KLF-100	KLF-200	KHM-100	KHM-200
Firing rate USGPH (oil)	0.55-0.65	0.55-0.65-0.75	0.85-1.00-1.15	0.55-0.65-0.75	0.85-1.00-1.10	0.55-0.65-0.75	0.85-1.00-1.15
Input capacity MBTU/H (oil)	77-91	77-91-105	119-147-161	77-91-105	119-140-154	77-91-105	119-147-161
Output capacity MBTU/H (oil)	74-87	66-79-91	102-126-139	66-79-91	102-119-132	66-79-91	102-126-139
AFUE % (oil)	95.8	86.2 to 87.1	86.5 to 87.8	86.2 to 87.1	86.3 to 88.6	86.0 to 86.8	86.4 to 87.5
ENERGY STAR certification at every firing rate* (oil, ECM motor only)	Yes	Yes	Yes	Yes	Yes	Yes	Yes
Input capacity MBTU/H (gas)	N/A	105	155	105	155	105	155
Output capacity MBTU/H (gas)	N/A	87	131	87	131	87	131
AFUE % (gas)	N/A	83.5	83.5	83.5	83.5	83.5	83.5
A/C ready electronic operating control	Yes	Yes	Yes	Yes	Yes	Yes	Yes
Chimney vent	No	Yes	Yes	Yes	Yes	Yes	Yes
Direct vent – Granby DVS (oil)	No	Optional	Optional	Optional	Optional	Optional	Optional
Approved plastic through the wall or roof venting options	Yes	No	No	No	No	No	No
PSC blower motor hp – number speeds	N/A	1/2 hp-4	3/4 hp-4	1/2 hp-4	3/4 hp-4	1/2 hp-4	3/4 hp-4
CFM at 0.50" wc (ext. static pressure)	N/A	1275	2030	1275	2030	1275	2030
ECM blower motor hp – number speeds*	1/2 hp-5	1/2 hp-5	3/4 hp-5	1/2 hp-5	3/4 hp-5	1/2 hp-5	3/4 hp-5
CFM at 0.50" wc (ext. static pressure)	1230	1230	1910	1230	1910	1230	1910

**Dimensions (in.)**

Height	36 7/8	33	33	29 3/8	35 1/8	46 1/4	49 7/8
Width	21 1/2	21 1/2	21 1/2	21 1/2	21 1/2	21 7/16	21 7/16
Depth	50 1/4	49 1/8	55 1/8	53 5/8	52 5/8	26	30
Supply plenum size	20 x 20	20 x 20	20 x 24	18 x 21 3/4	20 x 24	20 x 20	24 x 20
Return plenum size	20 x 20	20 x 20	20 x 22	18 x 20 3/4	20 x 20	18 x 18	23 x 18

\*Certification to ENERGY STAR version 4.0 (with ECM motor)

**ABOUT GRANBY**

Since 1954, Granby Industries has been the North American leader in manufacturing and marketing steel tanks for storage of oil products and high-efficiency boilers and furnaces. Our continuous research and development program answers the needs of our customers in regards to energy efficiency and comfort by providing affordable and innovative solutions.

Granby Industries offers a complete line of safe, durable and reliable quality-built products. For over five decades, service and innovation have helped Granby gain an enviable reputation as well as value-added expertise for its customers.



GRANBY FURNACES INC.  
 12118 Hwy 209, P.O.Box 637  
 Parrsboro, NS B0M 1S0 Canada  
 902-254-2543  
 1-800-477-4328

sales@granbyindustries.com







# CONFORTO

## GET THE MAXIMUM OUT OF YOUR HEATING APPLIANCE

AFUE\* **96.7%**  
UP TO (OIL)

### COMPARATIVE ANNUAL HEATING OIL CONSUMPTION CHART

	2,000 L	2,500 L	3,000 L
FURNACE AFUE OF 65%	3,000		
FURNACE AFUE OF 75%	2,600		
FURNACE AFUE OF 85% (ENERGYSTAR minimum)	2,294		
GRANBY CONFORTO 88.6%	2,213		
GRANBY CONFORTO CHE 95.8%	2,044		

Example of a yearly heating oil consumption (liters)

\* Annual Fuel Utilization Efficiency



### ECM HIGH-EFFICIENCY MOTORS VERSUS PSC MOTORS

## ENJOY UP TO 82% ELECTRICITY ENERGY EFFICIENCY WITH ECM<sup>†</sup> TECHNOLOGY!

Represents savings of up to 50% (watts) during heating and cooling mode and of up to 75% (watts) during continuous fan operation.

<sup>†</sup>Electronically controlled motor

# VENTING OPTIONS (OIL-FIRED ONLY)



## DIRECT VENT SYSTEM (DVS)

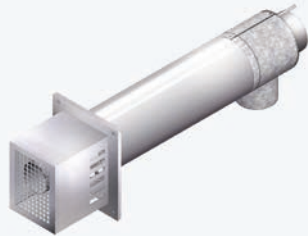

- Replaces conventional chimneys
- 100% stainless steel coaxial terminal
- Sealed combustion using balanced flue burners (oil-fired appliance only)
- Comes standard with an auto-reset pressure switch protection device in case of flue or air intake blockage
- Brings outside combustion air, ideal for air-tight homes
- Stainless steel flue pipe available in 10, 15 or 20-feet length



## COAXIAL PLASTIC VENTING THROUGH THE WALL OR THROUGH THE ROOF

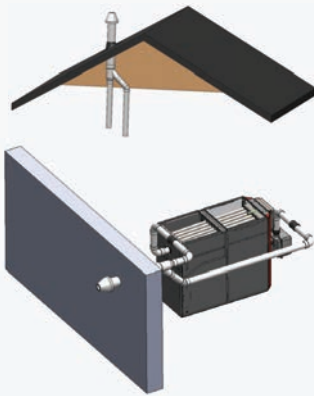

- Ideal for installation where there is no chimney
- Sealed combustion using balanced flue burner
- Simple installation

## TWO-PIPE PLASTIC VENTING THROUGH THE WALL

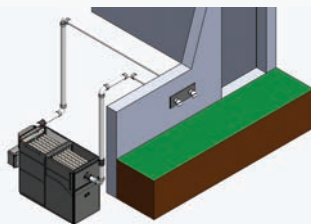

- Ideal for installation where there is no chimney
- Sealed combustion using balanced flue burner
- Can run greater distances than plastic coaxial venting
- Simple installation

## SINGLE-PIPE PLASTIC VENTING THROUGH AN EXISTING CHIMNEY CHASE

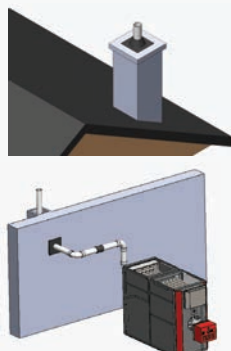

- Single-pipe venting using an existing chimney chase
- The most economical and simple venting option
- Single-pipe installation using a standard burner
- Can run long horizontal distances
- Ideal when through-the-wall venting options are not possible